

250 STAINLESS STEEL

DOUBLE DEFLECTION SUPPLY GRILLE HEAVY DUTY - SURFACE MOUNT

Job Name: _____

Tag Name: _____ Quantity: _____

Unit Size: _____

OPTIONS

- 304 Stainless Steel **(Standard)**
 - #4 Satin Finish **(Standard)**
- 316 Stainless Steel
 - #4 Satin Finish
- White Antimicrobial Epoxy Powdercoat Finish
- Other Color: _____
- 0.5" Blade Spacing **(Standard)**
- Top Inlet - (Select Shape/Size)
- Round Inlet - Size: _____
- Square Inlet - Size: _____
- Rectangle Inlet - Size: _____
 - Flanged
- S-44 Opposed Blade Damper
- Lay-In (No Screw Holes In Face)
(Order Size=Nominal -2.00")

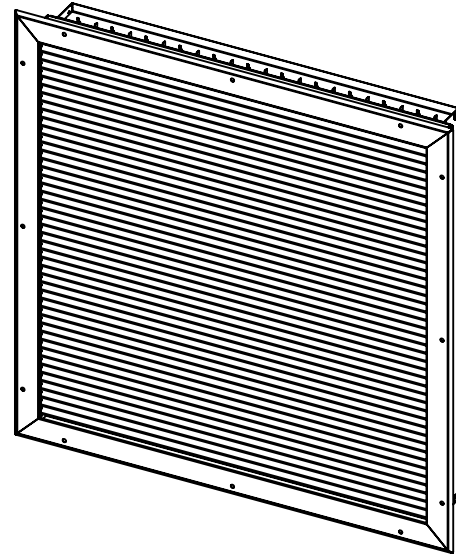

Blade Direction and Angle Options

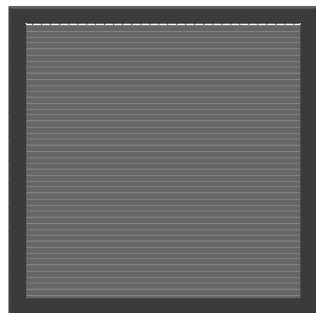

Horizontal @ 45°

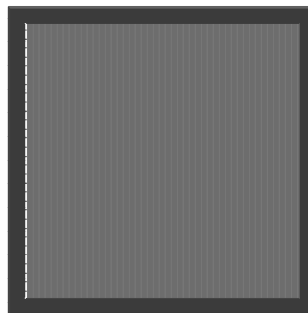

Vertical @ 45°

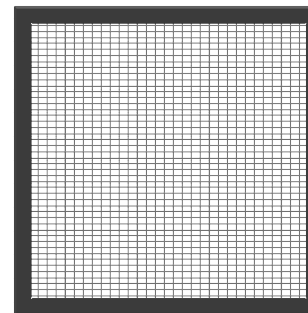

Horizontal @ 0°

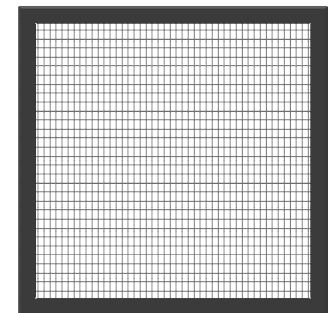

Vertical @ 0°



8701 Elmwood Ave #400
Kansas City, MO 63132
Ph: 816-231-5522 Fax: 816-231-8437
800-247-5746 Email: robhaake@ajmfg.us
Please Visit Our Web Site At: www.ajmfg.com

DRAWN SLG	MATERIAL 304SS	JOB NAME	TAG	QTY	REV # A
CHKD	FINISH #4 SATIN	ENGINEER	DRAWING NAME 250-HD-SURFACE MT		SHT 1/2
APRVD	SIZE	CONTRACTOR			SCL 1:10
					DO NOT SCALE

250 STAINLESS STEEL

DOUBLE DEFLECTION SUPPLY GRILLE

HEAVY DUTY - SURFACE MOUNT

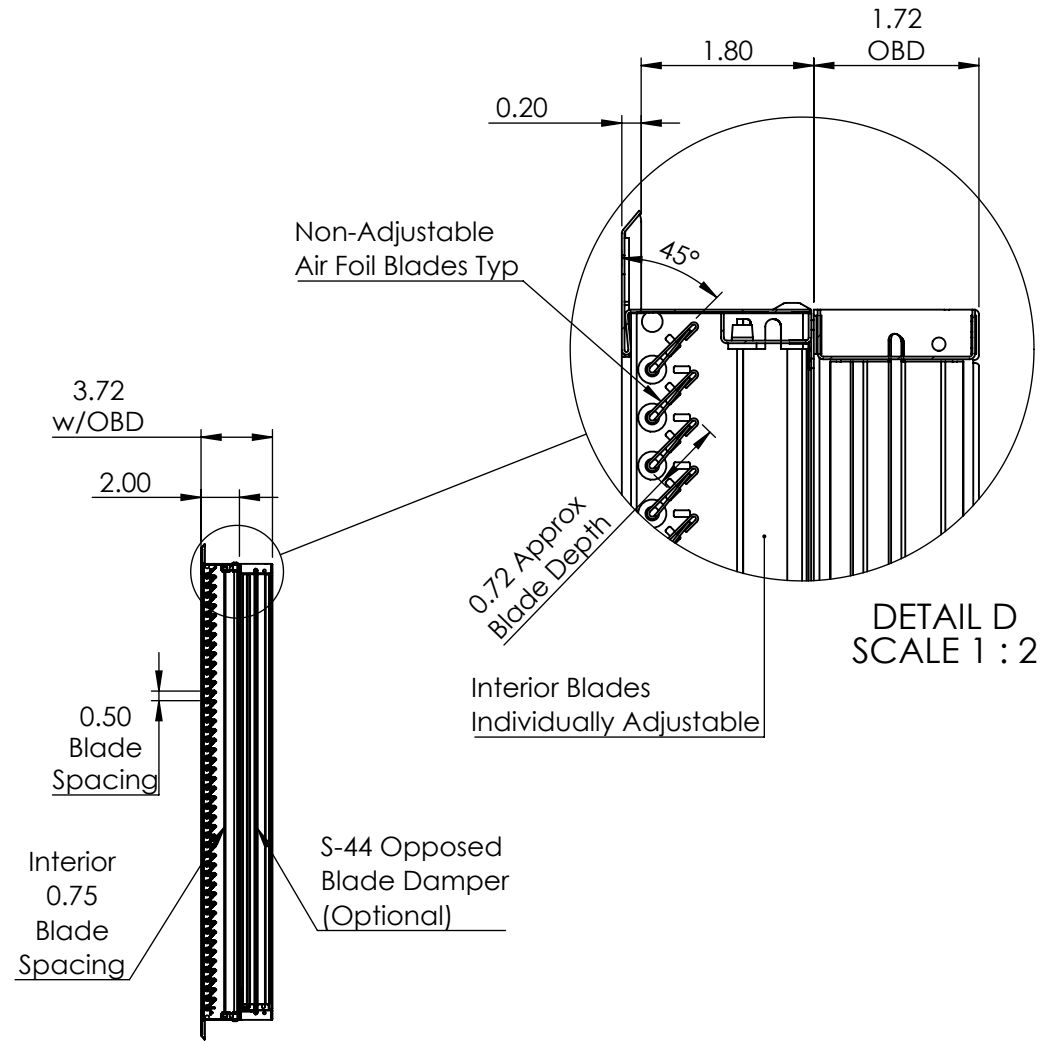
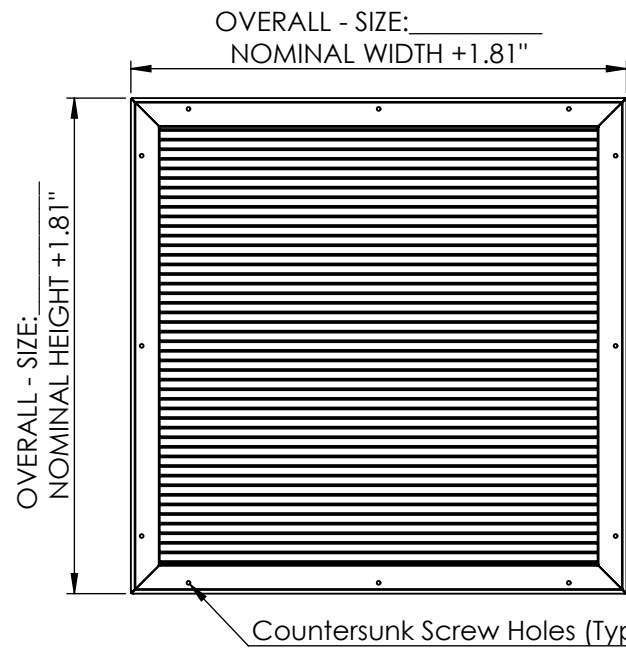
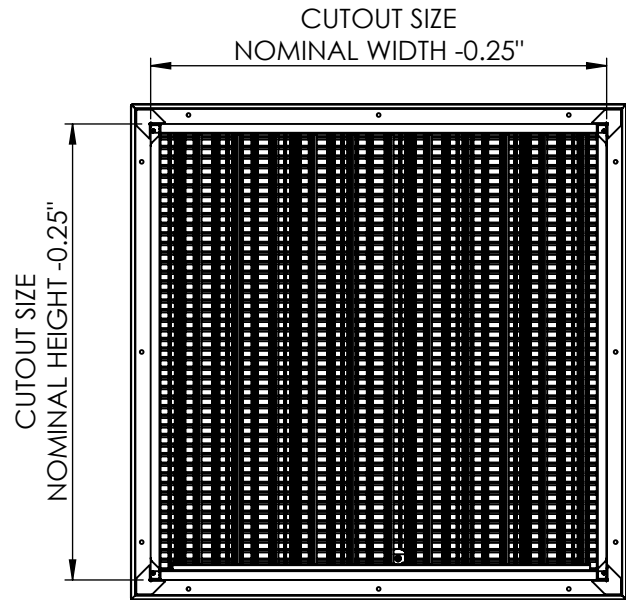

SECTION A-A



8701 Elmwood Ave #400
Kansas City, MO 63132
Ph:816-231-5522 Fax:816-231-8437
800-247-5746 Email:robhaake@ajmfg.us
Please Visit Our Web Site At: www.ajmfg.com

DRAWN SLG	MATERIAL 304SS	JOB NAME	TAG	QTY	REV # A
CHKD	FINISH #4 SATIN	ENGINEER	DRAWING NAME 250-HD-SURFACE MT		SHT 2/2
APRVD	SIZE	CONTRACTOR			SCL 1:10
					DO NOT SCALE